

ArcelorMittal Sheet Piling



ArcelorMittal

## Steel Sheet Piles

Flood defense and bank protection



- 2 Sheet pile walls - effective solutions for building and enhancing flood defenses and canal banks
- 4 Sheet pile walls - a highly advantageous constructive solution
- 6 The sheet pile wall technique - the ideal choice
- 8 Sheet pile walls and landscaping - for creative natural settings
- 10 Sheet pile walls in practice - Deptford Creek, UK & Manalapan, FL, USA

## Sheet pile walls - effective solutions for building and enhancing flood defenses and canal banks

Sheet pile walls can be used in a variety of ways for flood defense systems or for bank protection. For new embankments they can ensure watertightness, support, and stabilization. They are also used to strengthen existing embankments. When space is an issue, e.g. in ports or urban areas, sheet pile walls can form freestanding floodwalls.

The following examples constitute the seeds from which clients, designers, and engineers can grow creative solutions, and are by no means an exhaustive list of the possibilities for using sheet piles in embankments.

- In flood embankments, sheet pile walls can serve as a **cutoff**. The required watertightness of sheet pile cutoffs is often obtained through natural deposition of soil in the interlocks. If necessary, seepage through a sheet pile cutoff can be reduced by introducing highly effective sealing systems into the interlocks. A sheet pile cutoff not only reduces leakage, but also improves the overall stability of an embankment: sheet piles intersecting slip circles stabilize both the inner shoulder and the crest; the outer shoulder is stabilized by the lowering of the seepage line. With a sheet pile wall, seepage can be controlled: making the interlocks watertight reduces leakage, while natural flow can be recreated by making weep holes (see EAU 2012, R 51 [1]). In the latter case the embankment is protected from drying out. A sheet pile wall cannot be burrowed through by animals or penetrated by tree roots. This eliminates the risk of backward erosion outside the wall due to preferential flow pathways (piping) (ill. 1).

- With a sheet pile wall, not only can an embankment be made watertight, but it can also be modified to hold back a **larger design flood** without requiring greater landtake. This is a simple matter of designing the sheet pile wall to project the requisite height above the crest. This saves on the embankment footprint that would be necessary for a conventional embankment of the same height. Because of their bending strength, cantilevered sheet pile walls have no difficulty transferring high water pressures into the body of the embankment below. And just as when they stop at the crest, cantilevered sheet pile walls also stabilize the inner shoulder, together with the crest, and lower the seepage line in the outer shoulder (ill. 2).

Arles, France



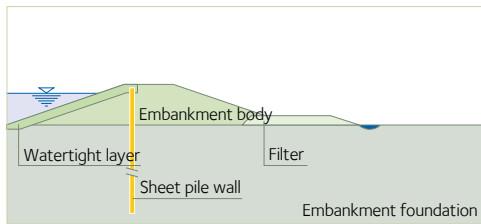

Illustration 1: cutoff

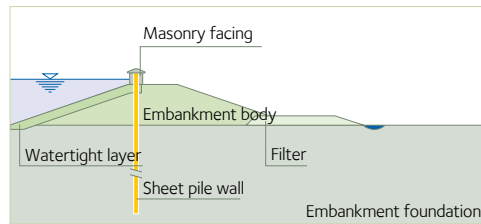

Illustration 2: raised design flood level

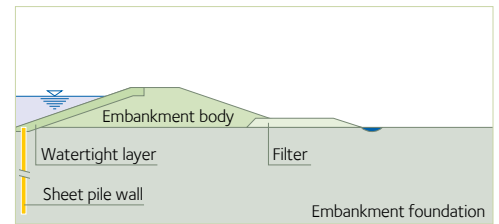

Illustration 3a: stabilization of inner shoulder (protection against scour)

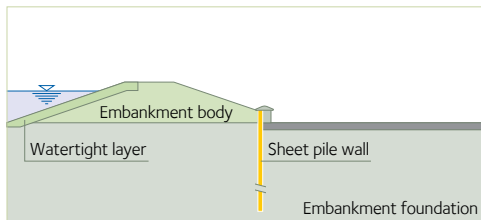

Illustration 3b: stabilization of outer shoulder

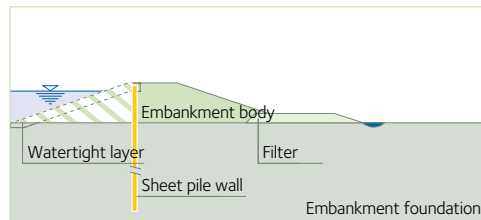

Illustration 3c: widening of waterway

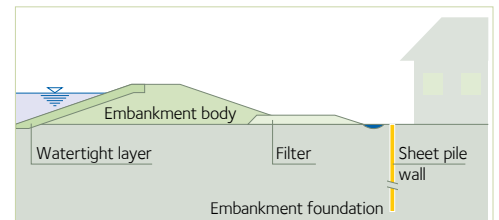

Illustration 4: protection against subsidence

- Sheet pile walls at the embankment toe play an important role in **slope stabilization** by directing the earth pressure of the shoulder into the foundation. This can be achieved by simply driving the sheet piles to a sufficient depth. If the soil height retained by the sheet pile wall is greater than ten to thirteen feet, it might be required to anchor the wall. Depending on the space available and the characteristics of the subsoil, the anchor force can be met by a deadman wall, prestressed ground anchors, or batter tension piles. The embankment shoulder stabilized in this manner can therefore be steeper than would be possible without a sheet pile wall. This solution makes for substantial space savings. And if the waterway is to be widened, sheet pile walls mean the bank profile can be vertical, not sloping (ill. 3a, 3b, 3c).

- Sheet pile walls can also **protect buildings from subsidence**. In this case the sheet pile wall is driven outside the embankment. Nearby buildings are thus isolated from the embankment, thereby eliminating the most unfavourable interactions between it and them (ill. 4).
- As a **flood wall**, a sheet pile wall can simply replace a flood embankment, without any reduction in performance. This option is of particular interest in ports or other locations where space is limited (ill. 5). It can also be used to protect isolated buildings, etc. In addition, a flood wall made of steel sheet piles can be connected to an earth embankment without the slightest problem.

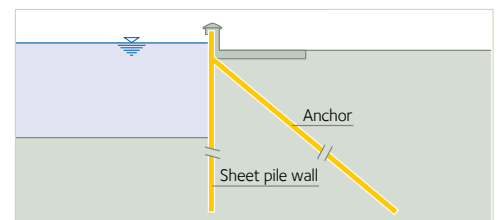

Illustration 5: flood wall



Placentia, Newfoundland, Canada

## Sheet pile walls – a highly advantageous constructive solution

For flood defense and canal-bank protection, sheet pile walls have a number of advantages.

- First of all, sheet piles are **cost- and time-effective**, principally as a result of the speed of construction. In addition to the possibility of an immediate start and rapid installation thereafter, sheet pile walls have a quality advantage due to being manufactured under controlled factory conditions. Together, these advantages make a difference due to the time savings. Given that no major enabling works are required, construction can start after a very short preparation period. The fact that a single component combines the functions of cutoff and support also helps optimize costs.
- State-of-the-art high frequency variable moment (resonance free) **vibratory pile drivers result in less disturbance** when sheet pile walls are installed. In particularly sensitive cases, sheet piles can be hydraulically pressed in to their full depth without the slightest disturbance (noise, vibration, etc.). And sheet pile walls can be driven as easily from water as from land.
- Sheet pile walls in flood defense schemes can regulate seepage to a certain extent. The interlocks can be sealed if the wall is to be **strictly watertight**. On the contrary, if the embankment soil is to be kept damp and protected from drying out, weep holes can be formed in the wall to allow water to flow naturally through the sheet piles. This also reduces the hydraulic pressure on the landward side as river flood levels drop.
- When cramped working space affects the construction of a flood defense system, a sheet pile wall is a one-of-its-kind solution that **saves space**. It is easily integrated into the landscape and meets the strictest aesthetic requirements (see our brochure on landscaping of river banks).
- The hazards resulting from the work of burrowing animals (burrows are preferential leakage channels) can be eliminated by using sheet pile walls. The same applies for the risks of root damage. The resulting penetration of impermeable zones and the creation of leakage paths can be prevented – contrary to when other systems are used. Cutoffs made from steel sheet piles open up new possibilities for ground treatment: since they are **impenetrable**, greening of embankment slopes can be envisaged. Plants must not hinder rigorous inspection of the embankment, however.



Greifswald-Ryck 1, Germany



Greifswald-Ryck 2, Germany



Wroclaw, Poland



Raising of an embankment in Zons (Germany) – removable panels used for temporarily raising the protection level above the permanent flood-protection level

- **Steel is ductile:** before a sheet pile wall can fail, a gradual process of deformation will be observed. This warning provides a reaction time during which structural defects can be identified and consequently remedied by means of appropriate corrective measures.
- Due to its **flexibility**, a sheet pile wall can be perfectly suitable for any geometrical arrangement. Without requiring any complex solutions, and with guaranteed maximum watertightness, it can be tied in to other embankment systems with conventional connection techniques. What is more, in extreme cases, the protection level of an embankment can be raised by installing **removable panels** on top of the sheet pile wall coping. Similarly, any openings in a flood wall can be closed off with removable panels if the need arises. Where pipes pass through an embankment – such places are always critical – , sheet pile walls provide a simple solution for preventing leakage along the pipes. The illustration (below) shows an example of how the intersection between a pipe and a sheet pile can be dealt with. The system shown is unaffected by settlement.

- Unlike other construction materials, sheet pile walls **can be withdrawn from the ground**, which is of particular interest in the case of temporary flood protection schemes. Steel sheet piles can be used again after extraction and are 100% recyclable: a life cycle analysis showed that in this case their environmental impact is remarkably low.

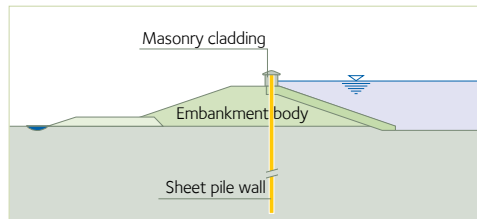

Raising of an embankment in Zons (Germany) – temporary closure of openings in the permanent flood defenses

Pipe penetration

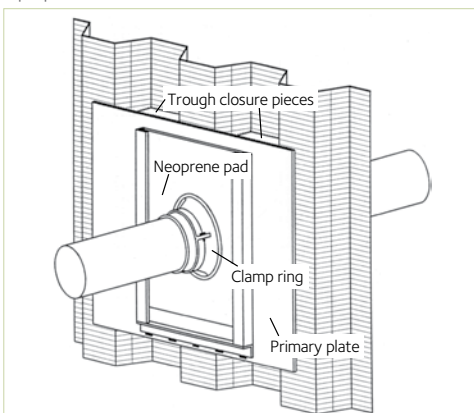

Givet, France

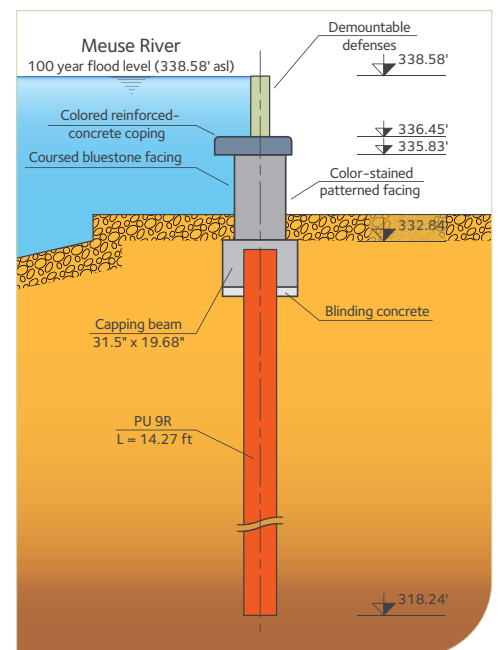

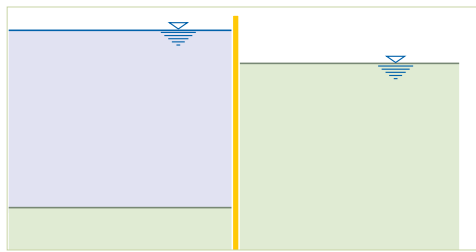

Illustration 1: Rising flood

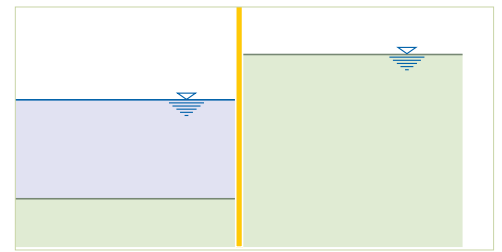

Illustration 2: Receding flood

## The sheet pile wall technique - the ideal choice

When choosing sheet pile sections, account must be taken of criteria with respect to both strength and the installation procedure. If the sheet piles are intended to form simply a watertight barrier, i.e. without any earth-retaining function, the choice of profiles will be based exclusively on installation and watertightness criteria. If, on the other hand, the sheet pile wall fulfils an earth-retaining function, the choice of profile will be based primarily on its geometrical characteristics. Obviously the designer will take account of other criteria (type of soil, installation procedure, etc.) which will determine the maximum sheet pile lengths that will not give rise to driving problems.

### Structural behaviour

Together, the cross-section of an embankment and the profile chosen for a sheet pile wall will elicit a number of possible solutions. These will depend on whether the project is for flood defense or bank protection, and on the characteristics of the site. It is therefore impossible to list design methods with universal values here. This chapter serves chiefly to present a series of fundamental principles which design engineers can bring to bear on their project.

The loads to which a sheet pile wall is exposed generally consist of pressures exerted jointly by earth and water. As far as hydraulic pressure is concerned, an analysis restricted to the **design flood** (ill. 1) is generally insufficient. Strength and stability are often governed by rapid drawdown of water after a relatively long period of flooding.

This is illustrated in the second load case (receding flood, ill. 2) where the danger of hydraulic failure of the foundation could prove to be determining for the design of the sheet pile wall. It is prohibited to consider for the design any material on the passive resistance side that could be carried away in extreme cases (ill. 3 - 5).

In addition to purely static stabilization, a sheet pile wall can also – indirectly – produce beneficial effects on the overall stability of an embankment:

- Lowering the seepage line enhances the stability of the outer shoulder which can consequently be steeper or optimized in other ways,

- Lengthening the seepage line enhances safety with respect to the risk of hydraulic failure,
- In the event of a leak through the impervious layer, a central sheet pile wall prevents the migration of fines, thereby preventing backward erosion in the landward shoulder. In addition, the wall significantly reduces the risk of piping caused by burrowing animals.

These additional positive effects are achieved above all when the sheet pile walls are socketed into an impermeable soil layer.

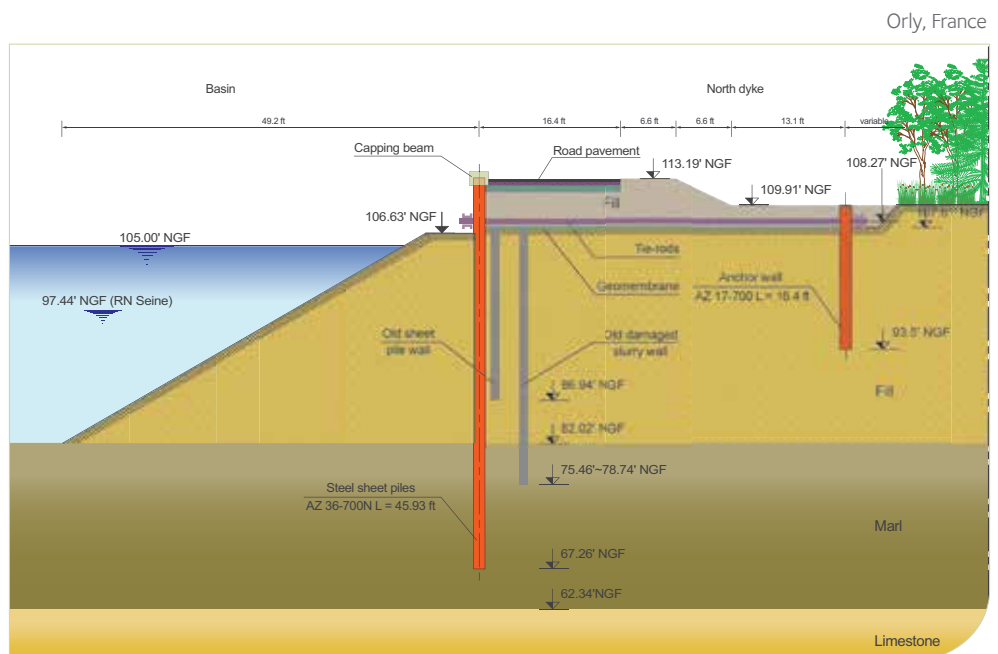

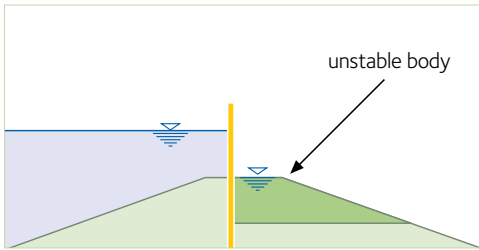

Illustration 3: Rising flood: part of the outer shoulder is at risk of being washed away by overflow.

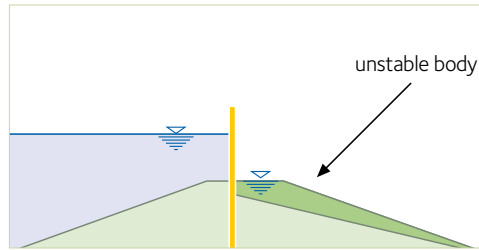

Illustration 4: Rising flood: slip of part of the flooded landward shoulder ( $\phi_{\text{wet}} < \phi_{\text{dry}}$ ).

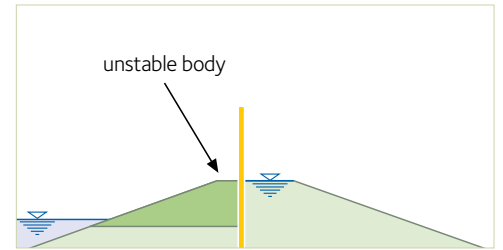

Illustration 5: Receding flood: part of the inner shoulder is at risk of being washed away by much stronger currents during the flood.

### Impermeability

The degree of impermeability of sheet pile walls can vary widely, depending on whether or not interlock sealing systems are used and on the types of sealants. More information regarding this aspect can be found in the brochure "The impervious steel sheet pile wall". If a sheet pile wall is to have an earth-retaining function yet the outer shoulder is to be prevented from drying out, weep holes can be arranged to allow water through (see EAU 2012, R51). Information on calculating flow rates across sheet pile walls can be found in European standard EN 12063, Annex E. It should be remembered, however, that if the sheet pile wall is not socketed into an impermeable soil layer, only numerical calculations can determine precisely the flow rate and seepage line (i.e. finite elements).

### Durability

The loss of thickness of a steel sheet pile in the ground is practically zero. Corrosion rates in fresh water are also low. For reasons of aesthetics, though, visible sheet pile walls often receive some form of **coating or cladding**. Dark colors are recommended, for they soil less quickly. More advice on coating systems can be found in the general catalogue "Steel sheet piles", in the chapter "Durability".

### Installation

Embankments are vulnerable to settlement and can therefore be affected by vibrations. Disturbance to the embankment can be greatly relieved through the use of state-of-the-art **vibratory rigs allowing variable eccentric moment**. If there is any doubt, a **vibration-logging system** can be used; it emits a warning signal when a given vibration threshold is exceeded. If this occurs, pre-drilling, hydraulic pressing, or impact driving should be used. With **impact driving**, higher vibration velocities are acceptable in most cases. **Hydraulic pressing**, on the other hand, does not generate any vibration at all. In all events, if the sheet pile wall is to serve as a cutoff, it is recommended that the greatest care be taken to ensure the integrity of the wall.

Stormwater retention basin, Lübeck, Germany





## Sheet pile walls and landscaping – for creative natural settings

With steel sheet pile walls, the appearance of canal banks can be very natural, meeting not only aesthetic criteria but also economic and ecological requirements. Whether sheet pile walls serve as flood defenses or as bank support, they have to fit as seamlessly as possible into the urban or rural landscape. They can be painted, clad with timber, brick, or stone, or masked by plants; suitable planting encourages the re-establishment of ecosystems which can be prejudiced by human intervention in the workings of nature.

### Appreciated in urban settings: the great diversity of stone cladding

In urban environments, it is often possible to clad steel sheet piles with aesthetically pleasing stone or blockwork. Bare sheet pile walls are most commonly encountered in industrial locations such as port structures (quay walls).

Brick or stone cladding offers enormous diversity in design, and in many cases can even be complemented and enhanced by appropriate plants. Using precast elements significantly increases the speed at which cladding can be installed. The stone used should take account

of local conditions. In urban areas, it is generally required that a flood defense system should not impede views of the river. This requirement can be met by leaving gaps in the wall that, when the need arises, can be closed off with removable systems. If required, an alternative flood defense system can be built with high-strength structural glass panels above the sheet pile wall.



Nervaux Canal, Troyes, France

Radunia Channel, Gdansk, Poland





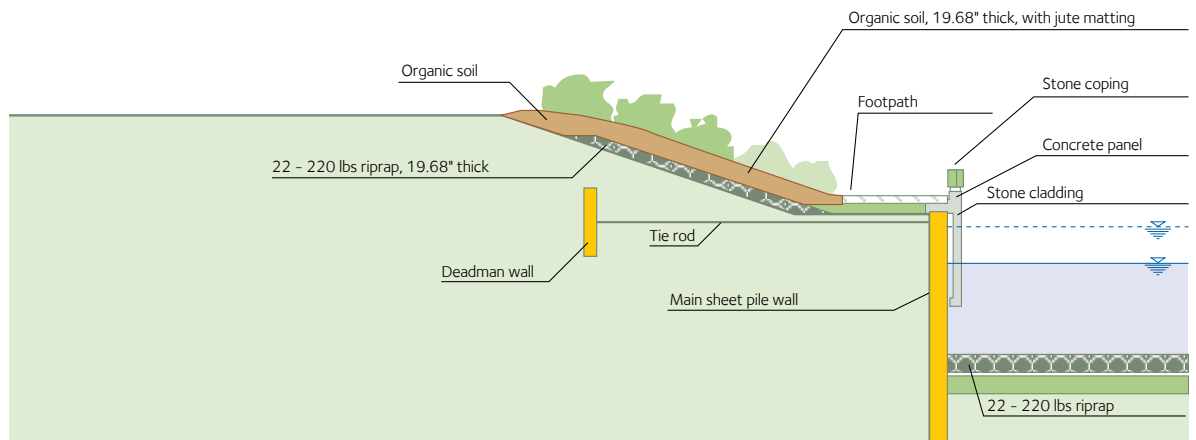

### Greened banks improve lifestyle quality

Adorned with plants, a sheet pile wall along the banks of a canal will take on attractive and natural attributes. Greening has a positive effect on landscape and the quality of life, especially since the banks of waterways are generally much appreciated as recreational areas. Since greening must take account of the local landscape and ecological requirements, its success will depend in large part on the plants selected.

Ideally, the natural ecosystem should be preserved by modifying it as little as possible and by complementing it in a properly targeted manner. Using sheet pile walls means embankment shoulders can be greened, since there is no risk of the watertight barrier being damaged by roots, etc. In the case of canal embankments, trees mean traffic benefits from a degree of protection from wind. It should be remembered, however, that plants should never be an obstacle to inspection of the embankment.

Just as the balconies or walls of a house can be decorated with flowers in hanging baskets, so can a sheet pile wall be embellished with 'biotope boxes'. These come in a variety of materials, shapes, colors, and placement possibilities, and can be used in combination.

Biotope boxes can be placed above or below the water line, depending on their purpose, i.e. whether intended for marshland plants, or more strictly aquatic or totally immersed plants. Two kinds are available: one rests against the outermost face of the sheet pile, the other nestles in the sheet pile trough.



### Considerations regarding sheet pile integration

The following aspects should be taken into account when cladding and/or greening sheet pile walls:

- A welded steel section or concrete foundation can serve as a support for masonry works.
- When choosing cladding, account should be taken of impact loading on both the water and the landward sides.
- Any cavities caused by water running down sheet pile walls should be filled so that loads are transferred directly to the steel barrier. It is important to prevent accumulation of large volumes of water in runoff cavities; large volumes of water could cause frost damage, efflorescence, and corrosion.
- If ancillary steel components are not attached in accordance with the best professional practice, there will be a risk of alteration of the metals in contact.
- For coated and greened sheet pile walls, it must be ensured that the part covered remains accessible. Otherwise maintenance would be more complicated.
- Wood can be used as a cladding material on condition that it is sufficiently durable.

More information on the subject can be found in the brochure "*Palplanches métalliques - Aménagements écologiques et paysagers des berges*" (in French language only).

### References

- [1] EAU 2012, *Empfehlungen des Arbeitsausschusses "Ufereinfassungen". Häfen und Wasserstrassen*. Ernst und Sohn, 2012, 688 p.



# Flood Defenses on River Thames

## Deptford Creek | UK

Deptford Creek is a tributary of the Thames in London inside the Thames Barrier. In order to **protect an estimated 33 000 households from flooding**, the Environment Agency identified five Wharves along Deptford Creek for immediate replacement. Existing anchored timber pile structures were assessed to be reaching a stage where failure was imminent. The five identified locations were Kent Wharf, Ash's Wharf, Thanet Wharf, Hilton's Wharf and Saxon Wharf.

At the highest frontage the **357.6 ft long Hilton's Wharf has a retained face of 22.97 ft**. Future development plans for the site precluded the use of permanent anchors to support the new wall and so an innovative solution facilitating a composite wall system (propped structure) was engineered by Jacobs / Volker Stevin.

Typical cross section at Hilton's Wharf

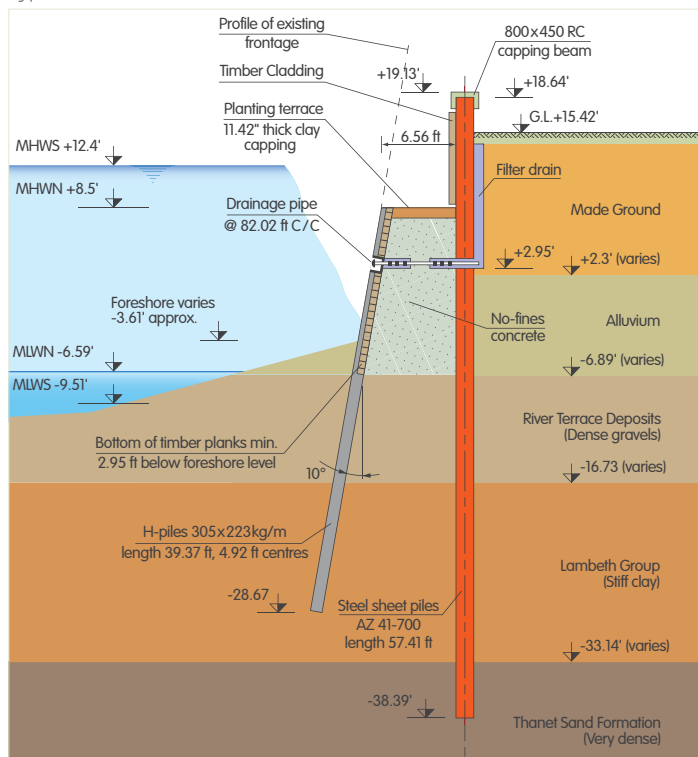

The new wall was to have a **100 year design life** and was to embrace the objectives of the Biodiversity Action Plan. The solution consists of a **steel sheet pile wall made of around 1 040 tonnes\*** of AZ 41-700 in grade S 430 GP steel grade, and in 54.13 ft up to 57.41 ft lengths. These are supported by a row of 39.37 ft long 305x223 HP bearing piles driven at a 10 degree rake in front of the sheet pile wall, with timber planking spanning between each HP pile. A mass concrete block was then poured between the sheet piles and HP piles lines down to the excavated depth, exposing the gravel layer, such that the structure acted in unison. The top of the concrete block level was Mean High Water Neap (MHWN) level such that the planting area above could offer maximised value of environmental habitat.

The construction of this **innovative "composite cantilever" sheet pile wall** presented its own challenges in that the working space was limited to only 32.81 ft behind the existing old walls which were in such poor state that they could not support construction surcharges. Besides, in some places the existing wall could not be subjected to vibration from conventional installation techniques.

To accommodate these requirements the AZ 41-700 sheet piles were installed behind the existing structure by an **ABI Vibrator MRZV-V**

(variable frequency) on a leader rig, or where vibration was to be minimized, the subcontractor Stent/Giken used the **Giken Crush Piler ECO 700S** with a press force of around 100 tonnes. This pressing equipment incorporates an auger to bore ahead of the pile toe before the press pushes the piles down in combination with water-jetting.

The sheet piles were then tied back to a **temporary deadman** (concrete block). A specialist bridging mat was then installed, spanning from the deadman to the sheet piles and avoiding any surcharge on the ground behind the main wall. From this mat the excavator could remove the old timber structure and dig down to expose the gravel layer. Additionally, the HP raker piles could also be installed from the bridging mat. After fitting the timber planking between the HP piles mass concrete was poured between the walls which when cured bound the wall and the supporting HP pile wall into a kind of "A frame" composite structure.

The deflections measured during the temporary stage were lower than predicted in the design calculations. The criteria for deflection during the final phase is 7.87 in at ULS with a surcharge load of 2.9 psi behind the wall. **A static reserve of steel thickness** was taken into account in the design in order to achieve the design life. No surface treatment was implemented.

The condition of the existing walls, the site area restrictions, the requirement for a cantilever solution and duty of care to the Natural Habitat combined to pose quite a complex problem. Jacobs Engineering with early contractor involvement from Volker Stevin, adopted a **combination of steel sheet piling and steel bearing piles to form a structure which elegantly met all technical and economic aspects of the project.**

\* Note: all weights for steel products in this document are expressed in metric tons. They are indicated either as "metric ton" or "tonne", or "t".



© Hayward Baker

## Manalapan Seawall

### Storm Protection/Erosion Control | Palm Beach, Florida | USA

In the two decades following World War II, the luxurious resort area of West Palm Beach nearly doubled in population as veterans stationed at the local air base returned to the city to live at the end of the war. Located on the east coast of Florida along the Atlantic Ocean, large estates were built seaside in the town of Manalapan, creating breathtaking views of the barrier islands while facing up against the most active hurricane path in the world.

In the 1960s, residents sought to protect the nearly 170 oceanfront properties against the ocean's surge by constructing sea walls of PMA 22 steel sheet piles driven into the beach sand with steel tiebacks anchored to concrete deadmen approximately 10 to 12 feet inland.

In late October 2012, Hurricane Sandy roared up the East Coast and produced a storm surge that overtopped the sea walls in South West Palm Beach. Stretching its damaging winds over 900 miles, Hurricane Sandy generated a destructive surge over an expansive part of the Atlantic coastline. Damage costs wreaked by Hurricane Sandy are well over \$50 billion, making it the second-most devastating storm in U.S. history.

In Manalapan, the sea water overtopped the sea walls, washed away the soil, exposed the concrete deadmen and the steel tieback anchors snapped. With its support system compromised, the steel sheet piles failed and fell toward the ocean. Sea water flooded the oceanfront properties and caused significant damage to the prime real estate.

The home owners needed to fix the damaged sea walls before the next hurricane season.

To further complicate things the regulation from the Environmental Protection Agency further expedited the timeline. The removal of the old steel sheet piles and the driving of the new sheet piles were to cease by the beginning of March

to avoid interrupting the seasonal nesting of sea turtles on the beach.

As with several other Sandy related projects along the East Coast of the US, the home owner's association and their engineer moved quickly to replace the damaged sea walls.

When the old sheets were extracted from the soil, the steel below the mud line was still 0.37 in thick, a testimony to the lack of corrosion without presence of oxygen.

Steel sheet piles, having proved the 50-year life rating from the first installation, were chosen again, but this time the product selected for the main sea wall was coated AZ 26-700 at a thickness of 0.48 in (with a 100-year design life).

In a majority of the ocean-side properties, the design consisted of a T-wall, with the main wall at a height of 8 feet above the mud line, an increase from the previous height of 5 feet. To stabilize the sea wall, shorter steel sheet piles were driven into the limestone at 28 ft to 30 ft depth perpendicular to the main wall, connected via C9 corner sections.

As the stabilizing sheets got further inland, shorter lengths of sheet pile were needed.

In an undamaged property at the southern-most tip of the island, the owner sought to prevent future damage by replacing the current sea wall with steel sheet pile, coated, with a cap and concrete deadmen with steel rod tiebacks (25 feet back from new wall).

At the end of the sea turtle nesting season, the Manalapan properties on the intracoastal side of the island began a second phase of the project: installation of steel sheet pile walls for boat slips.



**ArcelorMittal Commercial RPS S.à r.l.**  
Sheet Piling

66, rue de Luxembourg  
L-4221 Esch-sur-Alzette (Luxembourg)

E [sheetpiling@arcelormittal.com](mailto:sheetpiling@arcelormittal.com)  
[sheetpiling.arcelormittal.com](http://sheetpiling.arcelormittal.com)



Hotline: (+352) 5313 3105



[ArcelorMittalSP](#)



[ArcelorMittal Sheet Piling \(group\)](#)